



Protection Module for Surge Protection Barrier

M-LB-2.30.T3.M

- Protection module for 1 supply line
- Type 3 acc. to EN 61643-11
- Removable module for surge protection barrier M-LB-2.30.T3.D
- Easy replacement of protection modules without tools
- High discharge capacity
- Module can be exchanged under voltage (hot swap)



Connection

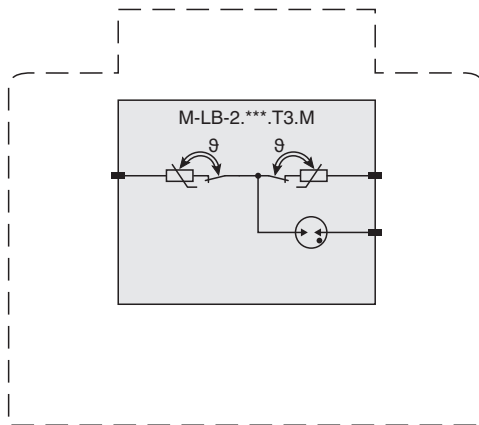

Dimensions

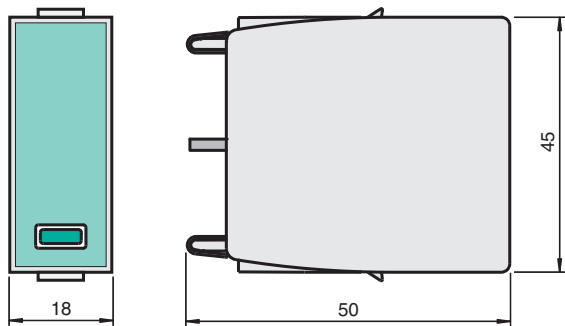

Release date: 2022-01-13 Date of issue: 2022-01-13 Filename: 263959_eng.pdf

Refer to "General Notes Relating to Pepperl+Fuchs Product Information".

Pepperl+Fuchs Group
www.pepperl-fuchs.com

USA: +1 330 486 0002
pa-info@us.pepperl-fuchs.com

Germany: +49 621 776 2222
pa-info@de.pepperl-fuchs.com

Singapore: +65 6779 9091
pa-info@sg.pepperl-fuchs.com

PF PEPPERL+FUCHS

Technical Data

General specifications		
Device type		type 3 acc. to EN 61643-11:2013 class III acc. to IEC 61643-1:2011
Number of protected supply lines		1
Electrical specifications		
Maximum continuous operating voltage	U_c	30 V AC 30 V DC
Nominal discharge current (8/20 μ s)	I_n	1 kA
Max. surge current (8/20 μ s)	I_{max}	2 kA
Indicators/settings		
Display elements		status display operating state (green) fault indication (red)
Directive conformity		
Low voltage		
Directive 2014/35/EU		EN 61643-11:2012
Conformity		
Degree of protection		IEC 60529:2013
Shock resistance		EN 60068-2:2010
Vibration resistance		EN 60068-2:2010
Ambient conditions		
Ambient temperature		-40 ... 80 °C (-40 ... 176 °F)
Mechanical specifications		
Degree of protection		IP20
Material		
Housing		thermoplastic, color grey , UL 94 V-0
Mass		approx. 50 g
Dimensions		18 x 45 x 50 mm (0.7 x 1.8 x 2 inch) (W x H x D) , 1 TE acc. to DIN 43880
Mounting		in the surge protection barrier M-LB-* .****.*
General information		
Supplementary information		Observe the certificates, declarations of conformity, instruction manuals, and manuals where applicable. For information see www.pepperl-fuchs.com .