



Transmitter Power Supply KFD2-CRG2-1.D

- 1-channel signal conditioner
- 24 V DC supply (Power Rail)
- Input 2-wire and 3-wire transmitters and 2-wire current sources
- Output 0/4 mA ... 20 mA
- 2 relay contact outputs
- Adjustable energized/de-energized delay
- Programmable high/low alarm
- Linearization function (max 20 points)
- Line fault detection (LFD)
- Up to SIL 2 acc. to IEC 61508/IEC 61511



Function

This signal conditioner provides the galvanic isolation between field circuits and control circuits. The device supplies 2-wire and 3-wire transmitters, and can also be used with current sources. Two relays and an active 0/4 mA ... 20 mA current source are available as outputs. The relay contacts and the current output can be integrated in security-relevant circuits. The current output is easily scaled. On the display the measured value can be indicated in various physical units. The device is easily configured by the use of keypad or with the PACTware configuration software. The input has a line fault detection. A fault is signaled by LEDs acc. to NAMUR NE44 and a separate collective error message output. For additional information, refer to the manual and www.pepperl-fuchs.com.

Connection

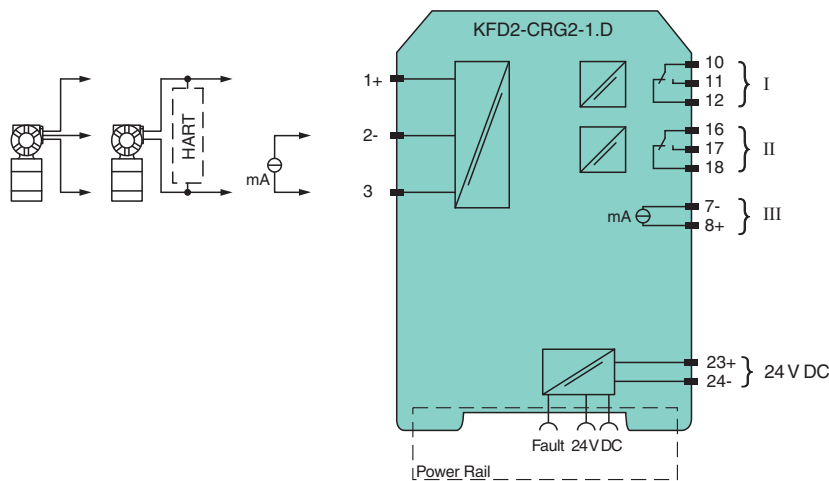

Technical Data

General specifications

Signal type Analog input

Functional safety related parameters

Safety Integrity Level (SIL) SIL 2

Supply

Connection Power Rail or terminals 23+, 24-

Rated voltage U_r 20 ... 30 V DC

Rated current I_r approx. 130 mA

Release date: 2022-02-24 Date of issue: 2022-02-24 Filename: 255621_eng.pdf

Refer to "General Notes Relating to Pepperl+Fuchs Product Information".

Pepperl+Fuchs Group
www.pepperl-fuchs.com

USA: +1 330 486 0002
pa-info@us.pepperl-fuchs.com

Germany: +49 621 776 2222
pa-info@de.pepperl-fuchs.com

Singapore: +65 6779 9091
pa-info@sg.pepperl-fuchs.com

PEPPERL+FUCHS

Technical Data

Power dissipation	2 W
Power consumption	2.5 W
Interface	
Programming interface	programming socket
Input	
Connection side	field side
Connection	terminals 1, 2, 3
Input I	
Input signal	0/4 ... 20 mA
Available voltage	≥ 15 V at 20 mA
Open circuit voltage/short-circuit current	24 V / 33 mA
Input resistance	45 Ω (terminals 2, 3)
Line fault detection	breakage I < 0.2 mA; short-circuit I > 22 mA
Output	
Connection side	control side
Connection	output I: terminals 10, 11, 12 output II: terminals 16, 17, 18 Output: analog terminals 8+, 7-
Output signal	0 ... 20 mA or 4 ... 20 mA
Output I, II	signal, relay
Contact loading	250 V AC / 2 A / cos φ ≥ 0.7 ; 40 V DC / 2 A
Mechanical life	5 x 10 ⁷ switching cycles
Output III	Signal, analog
Current range	0 ... 20 mA or 4 ... 20 mA
Open loop voltage	max. 24 V DC
Load	max. 650 Ω
Fault signal	downscale I ≤ 3.6 mA, upscale I ≥ 21.5 mA (acc. NAMUR NE43)
Energized/De-energized delay	0 ... 250 s , adjustable
Transfer characteristics	
Input I	
Accuracy	< 30 μA
Influence of ambient temperature	0.003 %/K (30 ppm)
Output I, II	
Response delay	≤ 200 ms at bounce from 0 ... 20 mA
Output III	
Resolution	≤ 10 μA
Accuracy	< 20 μA
Influence of ambient temperature	0.005 %/K (50 ppm)
Reaction time	< 650 ms at bounce from 0 ... 20 mA at the input, 90 % of output full-scale value
Galvanic isolation	
Input/Other circuits	reinforced insulation according to IEC/EN 61010-1, rated insulation voltage 300 V _{eff}
Output I, II/other circuits	reinforced insulation according to IEC/EN 61010-1, rated insulation voltage 300 V _{eff}
Mutual output I, II, III	reinforced insulation according to IEC/EN 61010-1, rated insulation voltage 300 V _{eff}
Output III/power supply and collective error	functional insulation acc. to IEC 62103, rated insulation voltage 50 V _{eff}
Interface/power supply and collective error	functional insulation acc. to IEC 62103, rated insulation voltage 50 V _{eff}
Indicators/settings	
Display elements	LEDs , display
Control elements	Control panel
Configuration	via operating buttons via PACTware
Labeling	space for labeling at the front
Directive conformity	
Electromagnetic compatibility	
Directive 2014/30/EU	EN 61326-1:2013 (industrial locations)

Release date: 2022-02-24 Date of issue: 2022-02-24 Filename: 255621_eng.pdf

Refer to "General Notes Relating to Pepperl+Fuchs Product Information".

Pepperl+Fuchs Group
www.pepperl-fuchs.com

USA: +1 330 486 0002
pa-info@us.pepperl-fuchs.com

Germany: +49 621 776 2222
pa-info@de.pepperl-fuchs.com

Singapore: +65 6779 9091
pa-info@sg.pepperl-fuchs.com

 PEPPERL+FUCHS



Technical Data

Low voltage	
Directive 2014/35/EU	EN 61010-1:2010
Conformity	
Electromagnetic compatibility	NE 21:2006
Degree of protection	IEC 60529:2001
Ambient conditions	
Ambient temperature	-20 ... 60 °C (-4 ... 140 °F)
Mechanical specifications	
Degree of protection	IP20
Connection	screw terminals
Mass	300 g
Dimensions	40 x 119 x 115 mm (1.6 x 4.7 x 4.5 inch) (W x H x D) , housing type C2
Mounting	on 35 mm DIN mounting rail acc. to EN 60715:2001
International approvals	
UL approval	E223772
General information	
Supplementary information	Observe the certificates, declarations of conformity, instruction manuals, and manuals where applicable. For information see www.pepperl-fuchs.com .

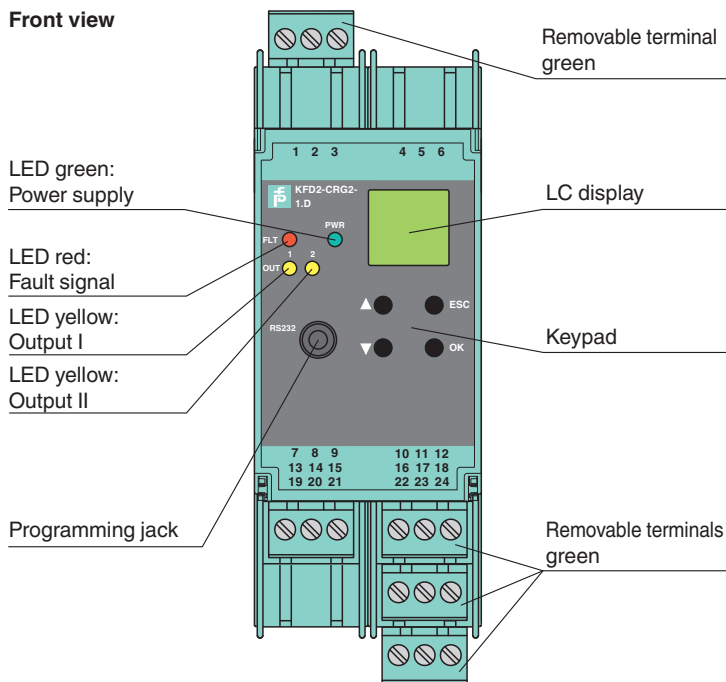
Assembly









Matching System Components





	DTM Interface Technology	Device type manager (DTM) for interface technology
	PACTware 5.X	FDT Framework
	K-ADP-USB	Programming adapter with USB interface

Release date: 2022-02-24 Date of issue: 2022-02-24 Filename: 255621_eng.pdf

Matching System Components

	KFD2-EB2	Power Feed Module
	UPR-03	Universal Power Rail with end caps and cover, 3 conductors, length: 2 m
	UPR-03-M	Universal Power Rail with end caps and cover, 3 conductors, length: 1,6 m
	UPR-03-S	Universal Power Rail with end caps and cover, 3 conductors, length: 0.8 m
	K-DUCT-GY	Profile rail, wiring comb field side, gray
	K-DUCT-GY-UPR-03	Profile rail with UPR-03-* insert, 3 conductors, wiring comb field side, gray

Accessories

	K-250R	Measuring resistor
	K-500R0%1	Measuring resistor
	KF-ST-5GN	Terminal block for KF modules, 3-pin screw terminal, green
	KF-CP	Red coding pins, packaging unit: 20 x 6

Characteristic Curve

Maximum Switching Power of Output Contacts

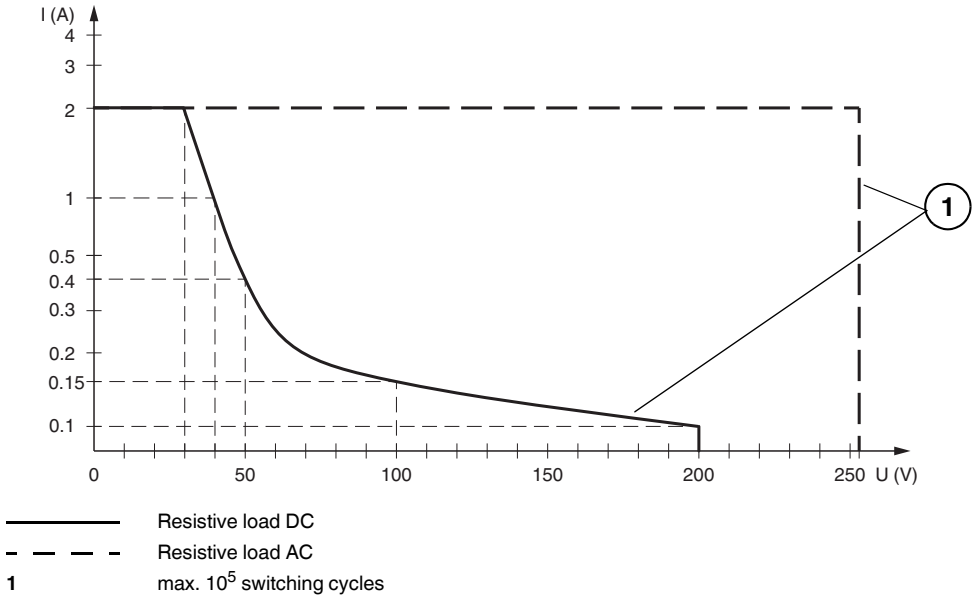

Release date: 2022-02-24 Date of issue: 2022-02-24 Filename: 255621_eng.pdf

Refer to "General Notes Relating to Pepperl+Fuchs Product Information".

Pepperl+Fuchs Group
www.pepperl-fuchs.com

USA: +1 330 486 0002
pa-info@us.pepperl-fuchs.com

Germany: +49 621 776 2222
pa-info@de.pepperl-fuchs.com

Singapore: +65 6779 9091
pa-info@sg.pepperl-fuchs.com

PEPPERL+FUCHS