

# SMART Current Driver KFD2-SCD2-Ex1.LK

- 1-channel isolated barrier
- 24 V DC supply (Power Rail)
- Current output up to 650 Ω load
- HART I/P and valve positioner
- Line fault detection (LFD)
- Accuracy 0.1 %
- SIL 2 (SC 3) acc. to IEC/EN 61508



## Function

This isolated barrier is used for intrinsic safety applications.

The device drives SMART I/P converters, electrical valves, and positioners in hazardous areas.

Digital signals are superimposed on the analog values at the field side or control side and are transferred bi-directionally.

Current transferred across the DC/DC converter is repeated at terminals 1 and 2. Terminals 2 and 3 are used when no short circuit detection is required.

An open or short field circuit presents a high impedance to the control side to allow alarm conditions to be monitored by the control system.

If the HART communication resistance in the loop is too low, the internal resistance can be used.

Test sockets for the connection of HART communicators are integrated into the terminals of the device.

A fault is signaled by LEDs and a separate collective error message output.

## Connection

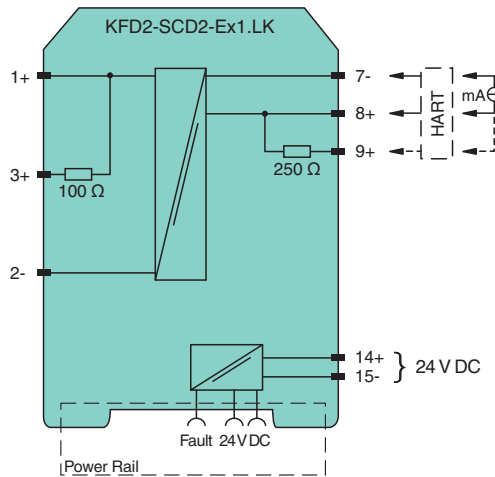
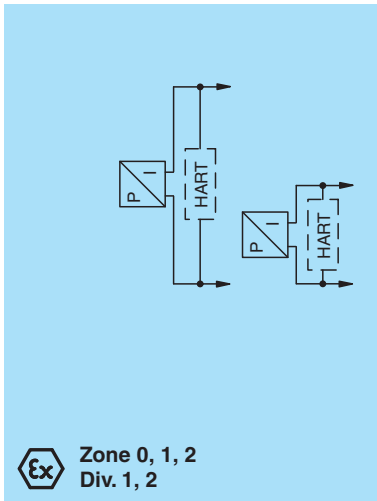

## Technical Data

### General specifications

Signal type: Analog output

### Functional safety related parameters

Safety Integrity Level (SIL): SIL 2

Systematic capability (SC): SC 3

### Supply

Connection: Power Rail or terminals 14+, 15-

Rated voltage:  $U_r$  19 ... 30 V DC

## Technical Data

Ripple		≤ 10 %
Rated current	$I_r$	≤ 30 mA at 24 V
Power dissipation		≤ 600 mW at 20 mA and 500 Ω load
Power consumption		≤ 700 mW
<b>Input</b>		
Connection side		control side
Connection		terminals 7-, 8+, (9+)
Input signal		4 ... 20 mA , limited to approx. 30 mA
Input voltage		open loop voltage of the control system ≤ 30 V
Voltage drop		approx. 6 V at 20 mA
Input resistance		field wiring open circuit : > 100 kΩ field wiring < 50 Ω : > 100 kΩ when using terminals 1 and 2
<b>Output</b>		
Connection side		field side
Connection		terminals 1+, 2- terminals 3+, 2- (no short circuit detection)
Voltage		≥ 13 V at 20 mA
Current		4 ... 20 mA
Load		100 ... 650 Ω , for terminals 1, 2 0 ... 550 Ω , for terminals 2, 3
Ripple		20 mV rms
Line fault detection		breakage, load > 100 kΩ, short-circuit, load < 50 Ω
<b>Fault indication output</b>		
Output type		open collector transistor (internal fault bus)
<b>Transfer characteristics</b>		
Deviation		at 20 °C (68 °F), 4 ... 20 mA < 0.1 % of full scale, incl. non-linearity and hysteresis
Influence of ambient temperature		< 2 μA/K (-20 ... 70 °C (-4 ... 158 °F)); < 4 μA/K (-40 ... -20 °C (-40 ... -4 °F))
Frequency range		field side into the control side: bandwidth with 0.5 V <sub>pp</sub> signal 0 ... 3 kHz (-3 dB) control side into the field side: bandwidth with 0.5 V <sub>pp</sub> signal 0 ... 3 kHz (-3 dB)
Rise time		10 to 90 % ≤ 10 ms
<b>Galvanic isolation</b>		
Input/Output		basic insulation according to IEC/EN 61010-1, rated insulation voltage 300 V <sub>eff</sub>
Input/power supply		basic insulation according to IEC/EN 61010-1, rated insulation voltage 300 V <sub>eff</sub>
Output/power supply		reinforced insulation according to IEC/EN 61010-1, rated insulation voltage 300 V <sub>eff</sub>
<b>Indicators/settings</b>		
Display elements		LEDs
Labeling		space for adhesive label at the front
<b>Directive conformity</b>		
Electromagnetic compatibility		
Directive 2014/30/EU		EN 61326-1:2013 (industrial locations)
<b>Conformity</b>		
Electromagnetic compatibility		NE 21:2017 EN 61326-3-2:2018
Degree of protection		IEC 60529
Protection against electrical shock		UL 61010-1:2012
<b>Ambient conditions</b>		
Ambient temperature		-40 ... 70 °C (-40 ... 158 °F)
<b>Mechanical specifications</b>		
Degree of protection		IP20
Connection		screw terminals
Mass		approx. 115 g
Dimensions		20 x 124 x 115 mm (0.8 x 4.9 x 4.5 inch) (W x H x D) , housing type B2
Mounting		on 35 mm DIN mounting rail acc. to EN 60715:2001
<b>Data for application in connection with hazardous areas</b>		

Release date: 2022-04-01 Date of issue: 2022-04-01 Filename: 295086\_eng.pdf

Refer to "General Notes Relating to Pepperl+Fuchs Product Information".

 Pepperl+Fuchs Group  
www.pepperl-fuchs.com

 USA: +1 330 486 0002  
pa-info@us.pepperl-fuchs.com

 Germany: +49 621 776 2222  
pa-info@de.pepperl-fuchs.com

 Singapore: +65 6779 9091  
pa-info@sg.pepperl-fuchs.com

 PEPPERL+FUCHS

## Technical Data

EU-type examination certificate		BAS 00 ATEX 7240 X	
Marking		Ⓜ II (1)G [Ex ia Ga] IIC Ⓜ II (1)D [Ex ia Da] IIIC Ⓜ I (M1) [Ex ia Ma] I	
Output		Ex ia, Ex iaD	
Voltage	$U_o$	25.2 V	
Current	$I_o$	93 mA	
Power	$P_o$	585.3 mW	
Internal capacitance	$C_i$	1.05 nF	
Internal inductance	$L_i$	0	
<b>Supply</b>			
Maximum safe voltage	$U_m$	250 V <sub>rms</sub> (Attention! The rated voltage can be lower.)	
<b>Input</b>			
Maximum safe voltage	$U_m$	250 V <sub>rms</sub> (Attention! The rated voltage can be lower.)	
Certificate		FIDI 22 ATEX 0002X	
Marking		Ⓜ II 3G Ex ec IIC T4 Gc [device in zone 2]	
<b>Galvanic isolation</b>			
Input/Output		safe electrical isolation acc. to IEC/EN 60079-11, voltage peak value 375 V	
Output/power supply		safe electrical isolation acc. to IEC/EN 60079-11, voltage peak value 375 V	
<b>Directive conformity</b>			
Directive 2014/34/EU		EN IEC 60079-0:2018 , EN 60079-11:2012 , EN IEC 60079-7:2015+A1:2018	
<b>International approvals</b>			
UL approval		E106378	
Control drawing		116-0345 (cULus)	
<b>IECEx approval</b>			
IECEx certificate		IECEx BAS 04.0014X	
IECEx marking		[Ex ia Ga] IIC , [Ex ia Da] IIIC , [Ex ia Ma] I Ex ec IIC T4 Gc	
<b>General information</b>			
Supplementary information		Observe the certificates, declarations of conformity, instruction manuals, and manuals where applicable. For information see <a href="http://www.pepperl-fuchs.com">www.pepperl-fuchs.com</a> .	

## Assembly

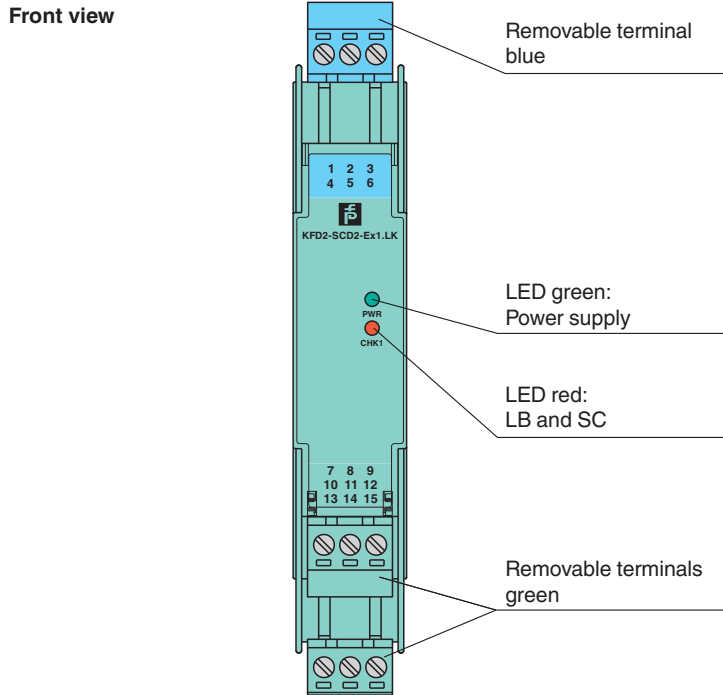







## Operation

**Lead monitoring, input characteristics**

During lead breakage (> 16 V) in the field the input resistance is > 100 kΩ, the field current is 0 mA, the input current is < 0.3 mA and the red LED is flashing.  
 During short circuit (< 50 Ω) in the field the input resistance is > 100 kΩ, the input current is < 100 μA, the field current is < 2.5 mA and the red LED is flashing.  
 The voltage drop at the current input (terminals 7-, 8+) is lower than 6 V.

## Matching System Components

	<b>KFD2-EB2</b>	Power Feed Module
	<b>UPR-03</b>	Universal Power Rail with end caps and cover, 3 conductors, length: 2 m
	<b>UPR-03-M</b>	Universal Power Rail with end caps and cover, 3 conductors, length: 1,6 m
	<b>UPR-03-S</b>	Universal Power Rail with end caps and cover, 3 conductors, length: 0.8 m
	<b>K-DUCT-BU</b>	Profile rail, wiring comb field side, blue
	<b>K-DUCT-BU-UPR-03</b>	Profile rail with UPR-03- * insert, 3 conductors, wiring comb field side, blue



## Accessories

	<b>KF-ST-5GN</b>	Terminal block for KF modules, 3-pin screw terminal, green
---	------------------	--

Release date: 2022-04-01 Date of issue: 2022-04-01 Filename: 295086\_eng.pdf

Refer to "General Notes Relating to Pepperl+Fuchs Product Information".

**Accessories**

	<p><b>KF-ST-5BU</b></p>	<p>Terminal block for KF modules, 3-pin screw terminal, blue</p>
	<p><b>KF-CP</b></p>	<p>Red coding pins, packaging unit: 20 x 6</p>

Release date: 2022-04-01 Date of issue: 2022-04-01 Filename: 295086\_eng.pdf

Refer to "General Notes Relating to Pepperl+Fuchs Product Information".

Pepperl+Fuchs Group  
www.pepperl-fuchs.com

USA: +1 330 486 0002  
pa-info@us.pepperl-fuchs.com

Germany: +49 621 776 2222  
pa-info@de.pepperl-fuchs.com

Singapore: +65 6779 9091  
pa-info@sg.pepperl-fuchs.com