

Switch Amplifier KFA5-SOT2-Ex2

- 2-channel isolated barrier
- 115 V AC supply
- Dry contact or NAMUR inputs
- Passive transistor output, non-polarized
- Line fault detection (LFD)
- Reversible mode of operation
- Up to SIL 2 acc. to IEC/EN 61508



Function

This isolated barrier is used for intrinsic safety applications. It transfers digital signals (NAMUR sensors/mechanical contacts) from a hazardous area to a safe area. Each proximity sensor or switch controls a passive transistor output for the safe area load. The normal output state can be reversed using switch S1 for channel I and switch S2 for channel II. Switch S3 enables or disables line fault detection of the field circuit. During an error condition, the transistors revert to their de-energized state and LEDs indicate the fault according to NAMUR NE44.

Connection

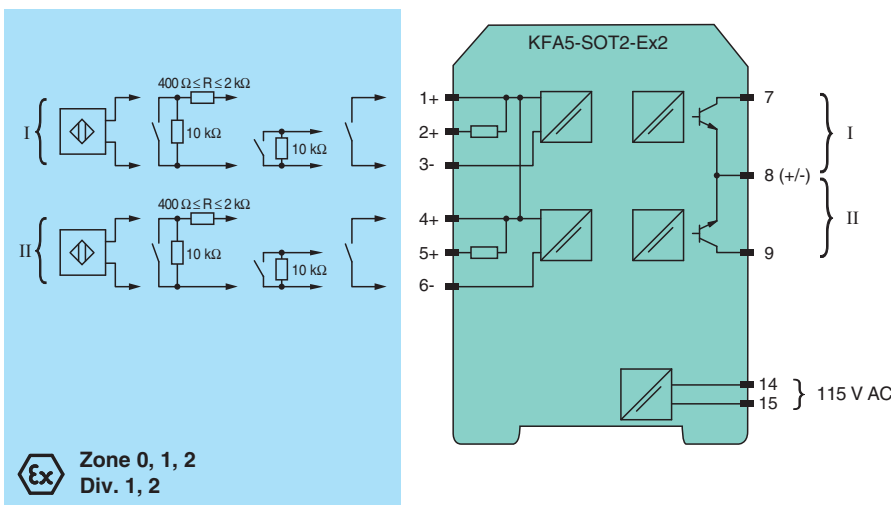

Technical Data

General specifications	
Signal type	Digital Input
Functional safety related parameters	
Safety Integrity Level (SIL)	SIL 2
Supply	
Connection	terminals 14, 15
Rated voltage	U_r 103.5 ... 126.5 V AC, 45 ... 65 Hz
Power dissipation	1 W
Power consumption	max. 1.5 W
Input	
Connection side	field side

Release date: 2022-01-10 Date of issue: 2022-01-10 Filename: 233751_eng.pdf

Refer to "General Notes Relating to Pepperl+Fuchs Product Information".

Pepperl+Fuchs Group
www.pepperl-fuchs.com

USA: +1 330 486 0002
pa-info@us.pepperl-fuchs.com

Germany: +49 621 776 2222
pa-info@de.pepperl-fuchs.com

Singapore: +65 6779 9091
pa-info@sg.pepperl-fuchs.com

PEPPERL+FUCHS

Technical Data

Connection	terminals 1+, 2+, 3-; 4+, 5+, 6-	
Rated values	acc. to EN 60947-5-6 (NAMUR), see manual for electrical data	
Open circuit voltage/short-circuit current	approx. 8 V DC / approx. 8 mA	
Switching point/switching hysteresis	1.2 ... 2.1 mA / approx. 0.2 mA	
Line fault detection	breakage $I \leq 0.1$ mA , short-circuit $I > 6$ mA	
Output		
Connection side	control side	
Connection	output I: terminals 7, 8 ; output II: terminals 8, 9	
Switching voltage	max. 40 V	
Switching current	max. 100 mA , short-circuit protected	
Signal level	1-signal: switching voltage - 2.5 V max. at 10 mA switching current or 3 V max. at 100 mA switching current 0-signal: switched off (off-state current ≤ 10 μ A)	
Output I, II	signal ; electronic output, passive	
Transfer characteristics		
Switching frequency	≤ 5 kHz	
Galvanic isolation		
Input/Output	reinforced insulation according to IEC/EN 61010-1, rated insulation voltage 300 V _{eff}	
Input/power supply	reinforced insulation according to IEC/EN 61010-1, rated insulation voltage 300 V _{eff}	
Output/power supply	reinforced insulation according to IEC/EN 61010-1, rated insulation voltage 300 V _{eff}	
Output/Output	not available	
Indicators/settings		
Display elements	LEDs	
Control elements	DIP switch	
Configuration	via DIP switches	
Labeling	space for labeling at the front	
Directive conformity		
Electromagnetic compatibility		
Directive 2014/30/EU	EN 61326-1:2013 (industrial locations)	
Low voltage		
Directive 2014/35/EU	EN 61010-1:2010	
Conformity		
Electromagnetic compatibility	NE 21:2012	
Degree of protection	IEC 60529	
Ambient conditions		
Ambient temperature	-20 ... 60 °C (-4 ... 140 °F)	
Mechanical specifications		
Degree of protection	IP20	
Connection	screw terminals	
Mass	approx. 150 g	
Dimensions	20 x 119 x 115 mm (0.8 x 4.7 x 4.5 inch) (W x H x D) , housing type B2	
Mounting	on 35 mm DIN mounting rail acc. to EN 60715:2001	
Data for application in connection with hazardous areas		
EU-type examination certificate	PTB 98 ATEX 2164	
Marking	⊕ II (1) G [Ex ia] IIC ⊕ II (1) D [Ex ia] IIIC	
Input	Ex ia IIC, Ex ia IIIC	
Voltage	U _o	10.5 V
Current	I _o	13 mA
Power	P _o	34 mW (linear characteristic)
Supply		
Maximum safe voltage	U _m	126.5 V AC (Attention! U _m is no rated voltage.)
Output		
Maximum safe voltage	U _m	253 V AC (Attention! The rated voltage can be lower.)

Release date: 2022-01-10 Date of issue: 2022-01-10 Filename: 233751_eng.pdf

Technical Data

Galvanic isolation	
Input/input	not available
Input/Output	safe electrical isolation acc. to IEC/EN 60079-11, voltage peak value 375 V
Input/power supply	safe electrical isolation acc. to IEC/EN 60079-11, voltage peak value 375 V
Directive conformity	
Directive 2014/34/EU	EN 60079-0:2012+A11:2013, EN 60079-11:2012
International approvals	
UL approval	
Control drawing	116-0145
CSA approval	
Control drawing	116-0047
General information	
Supplementary information	Observe the certificates, declarations of conformity, instruction manuals, and manuals where applicable. For information see www.pepperl-fuchs.com .

Assembly

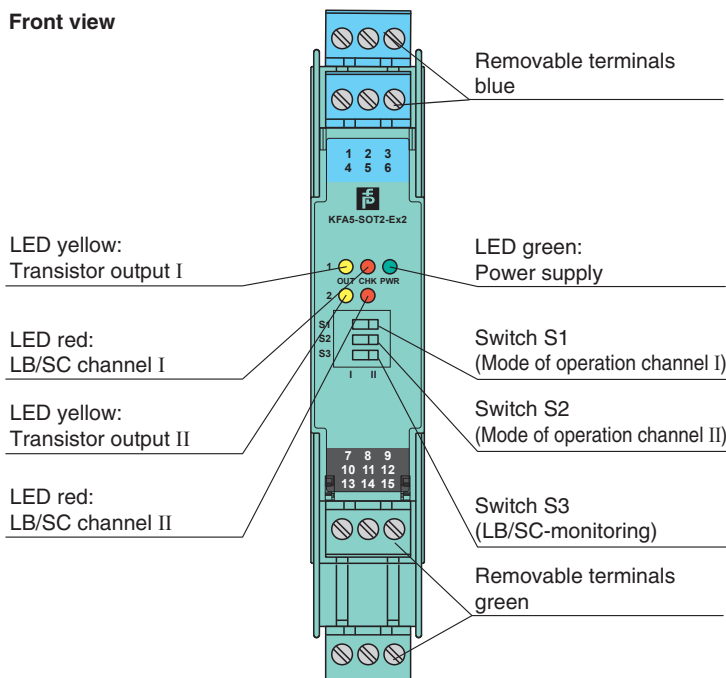

Front view



Matching System Components

	K-DUCT-BU	Profile rail, wiring comb field side, blue
---	------------------	--



Accessories

	F-NR3-Ex1	NAMUR Resistor Network
	KF-ST-5GN	Terminal block for KF modules, 3-pin screw terminal, green

Release date: 2022-01-10 Date of issue: 2022-01-10 Filename: 233751_eng.pdf

Refer to "General Notes Relating to Pepperl+Fuchs Product Information".

Accessories

	KF-ST-5BU	Terminal block for KF modules, 3-pin screw terminal, blue
	KF-CP	Red coding pins, packaging unit: 20 x 6

Configuration

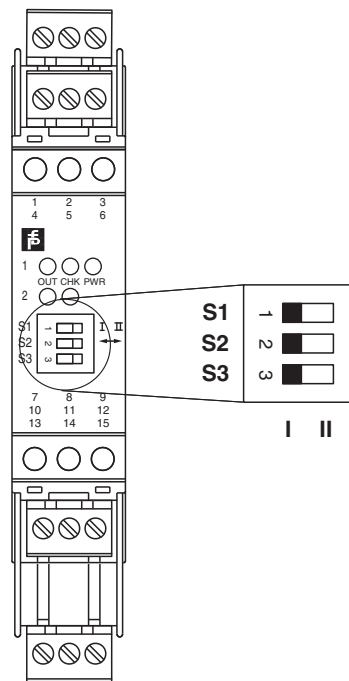

Switch position

S	Function		Position
1	Mode of operation output I active	with high input current	I
		with low input current	II
2	Mode of operation output II active	with high input current	I
		with low input current	II
3	Line fault detection	ON	I
		OFF	II

Operating states

Control circuit	Input signal
Initiator high impedance/contact opened	low input current
Initiator low impedance/contact closed	high input current
Lead breakage, lead short circuit	Line fault

Factory setting: switch 1, 2 and 3 in position I

Release date: 2022-01-10 Date of issue: 2022-01-10 Filename: 233751_eng.pdf